

### ■ General Description

OCH2993R is a fan motor driver for the single coil brushless DC motor. With its high efficient direct PWM control mode, OCH2993R controls the speed of brushless DC motor with an external hall switch IC. OCH2993R is suitable to drive variable speed motors for personal computer's power supply radiation fans and CPU coolers.

OCH2993R integrates PWM fan speed control, minimum speed mode, soft start, soft switch, fan tachometer, lock protection, auto restart and Hall IC power circuit. PWM mode controls fan speed in low noise and low vibration ways by adjusting PWM signal duty. OCH2993R can set minimum fan speed by presetting MINSP voltage. With soft start function, OCH2993R can effectively reduce the peak current when power on. To reduce fan driver audible noise and power loss, the OCH2993R features a soft on/off phase transition and automatic phase-lock function of the motor winding BEMF and current.

Robust protections in OCH2993R include under-voltage lockout (UVLO), rotor deadlock protection, over current protection (OCP) and thermal shutdown.

The OCH2993R requires a minimal number of external components to save solution cost. The OCH2993R is available in TSSOP16L-EP packages.

### ■ Features

- Supporting speed: Max. 40000 Rpm/Min.
- Wide Operating Input Voltage Range: 3.5V~18V  
Integrated Power MOSFETs: Total 220mΩ(High side + Low side)
- PWM Fan Speed Control
- Programmable Minimum Fan Speed
- MINSP Setting Minimum Fan Speed
- Soft On/Off Phase Transition
- 5S Soft Start and Soft Restart Function
- RD Signal Output
- Over Temperature Protection
- External Hall Switch
- Lock-shutdown protection & auto-restart function
- Automatic Phase Lock Detection of Winding BEMF and Current Zero-Crossing
- 15KHz to 60kHz PWM Input Frequency Range
- Fixed 26kHz Output Switching Frequency
- OCP (Over Current Protection)
- Current Limit & Soft Start and Soft Restart
- Thermal Protection and Automatic Recovery
- Built-In Input UVLO
- -40°C ~ + 105°C Temperature Range
- RoHS Compliant
- TSSOP-16L-EP Packages

### ■ Applications

- Power、Industrial product、Equipment or Servers
- Single Coil DC Brushless DC Motor

### ■ Pin Configuration

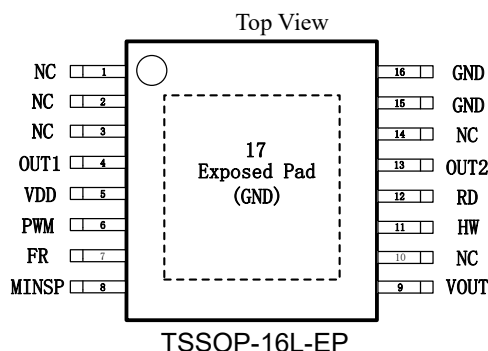

Figure 1, Pin Assignments Of OCH2993R

Pin Name	TSSOP16L-EP	Pin Function
NC	1,2,3,10,14	No Connection
OUT1	4	Output 1
VDD	5	Positive Power Supply
PWM	6	PWM Signal Input
FR	7	Inductive polarity Or Rotation Direction Control Pin,
MINSP	8	Input to set minimum speed or fan off range
VOUT	9	Regulator Output( Power supply for external HALL switch)
HW/SCL	11	Hall switch input(connect the external Hall Switch output)
RD	12	<b>RD Signal Output. This is an open-drain output.</b>
OUT2	13	Output 2
GND	15, 16, Exposed pad	Ground



■ **Typical Application Circuit**

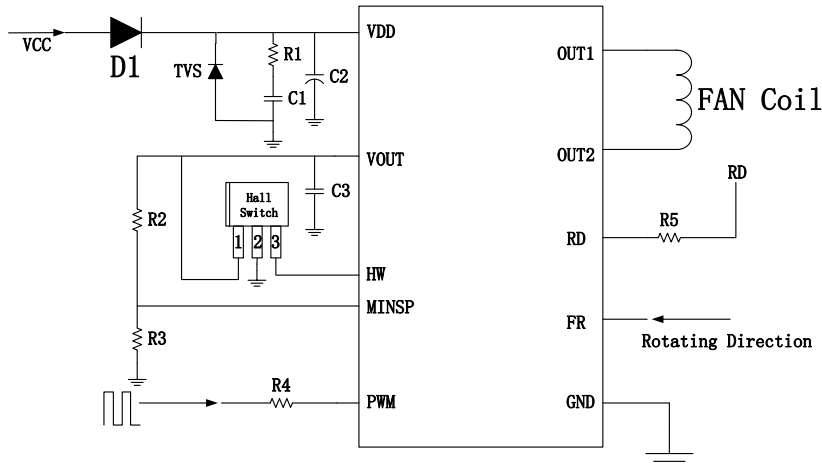

Figure 2, Typical Application Circuit Of OCH2993R (TSSOP16L-EP)

Note1:

- 1) Must use least C1=10uF~22uF and R1=1~2Ω (Typ.) for the decoupling between VDD and GND and place the capacitor as close to the IC as Possible.
- 2) A TVS diode is needed in application.
- 3) C2 is Electrolytic Capacitor, the typical value is 10uF~47uF.
- 4) C3 is Optional, the typical value is 1uF.
- 5) R2/R3 value decided the minimum output duty setting.
- 6) R4/R5, the typical value R4 is 10kΩ, R5 is 100Ω.

■ **Ordering Information**

Part Number	Package Type	Packing Qty.	Temperature	Eco Plan	Lead
OCH2993REFAD	TSSOP-16L-EP	2500pcs/Reel	-40 ~ +105°C	RoHS	Cu

■ **Block Diagram**

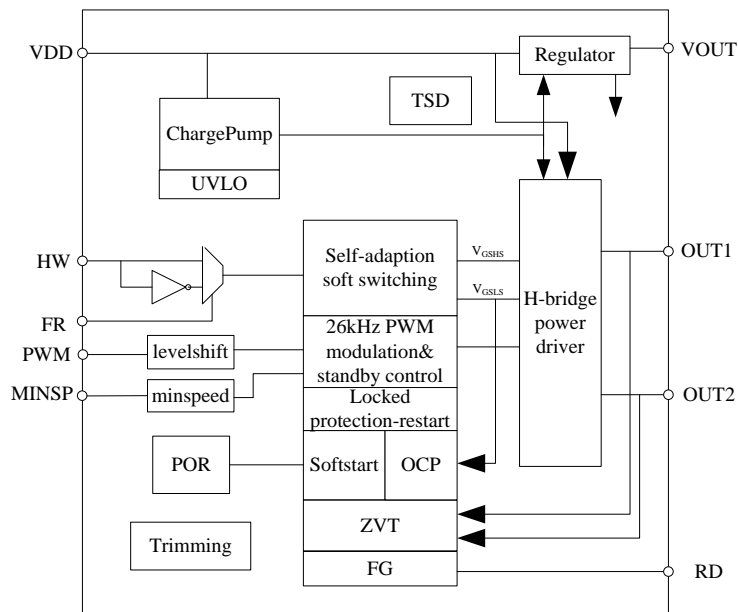

Figure 4, Block Diagram Of OCH2993R



■ **Absolute Maximum Ratings<sup>2/3</sup>** ( $T_A=25^{\circ}\text{C}$ , unless otherwise noted)

Parameter	Symbol	Rating	Unit
V <sub>DD</sub> Pin to GND	V <sub>DD</sub>	-0.3 ~ +23	V
OUT1,2 Pin to GND	V <sub>OUT1,2</sub>	-0.3 ~ +23	V
PWM Pin to GND	V <sub>PWM</sub>	-0.3 ~ +23	V
RD Pin to GND	V <sub>RD</sub>	-0.3 ~ +23	V
Peak Output Current	I <sub>O(PEAK)</sub>	5.0	A
V <sub>OUT</sub> Pin to GND	V <sub>VOUT</sub>	-0.3 ~ 7	V
HW Pin to GND	V <sub>HW</sub>	-0.3 ~ 7	V
FR Pin to GND	V <sub>FR</sub>	-0.3 ~ 7	V
Junction temperature	T <sub>J</sub>	150	°C
Thermal Resistance(SSOP16-EP)	$\theta_{JA}$	54	°C/W
Storage Temperature Range	T <sub>S</sub>	-55 ~ +150	°C
Maximum Soldering Temperature (at leads, 10 sec)	T <sub>LEAD</sub>	260	°C

Note2: The maximum dissipation power  $P_D$  allowed at any ambient temperature point is calculated:  $P_D(\text{max}) = (T_J - T_A) / \theta_{JA}$ ,  $T_J=150^{\circ}\text{C}$ . When applied, do not exceed the maximum rating to prevent chip damage, and work for a long time at maximum rating may affect chip reliability.

Note 3: The device is not guaranteed to function outside of its operating conditions.

■ **Recommended Operating Conditions<sup>4</sup>**

Parameter	Symbol	Rating	Unit
V <sub>DD</sub> Pin Voltage to GND	V <sub>DD</sub>	3.5 ~ 18	V
MINSP Pin to GND	V <sub>MINSP</sub>	0 ~ V <sub>VOUT</sub>	V
HW Pin to GND	V <sub>HW</sub>	0 ~ V <sub>VOUT</sub>	V
FR Pin to GND	V <sub>FR</sub>	0 ~ V <sub>VOUT</sub>	V
Operating Temperature Range	T <sub>A</sub>	-40 ~ +105	°C
Junction Temperature Range	T <sub>J</sub>	-40 ~ +150	°C

Note4: In practical application, the effect of fan coil heating on the chip must take into account, with the actual over temperature protection point of actual test of high temperature fan for reference. On the basis of pre leave relatively safe temperature allowance, avoid chip in the critical limit (maximum ratings) for a long time and affects the reliability.



**■ Electrical Characteristics**

Typical values are at  $T_A = +25^{\circ}\text{C}$ ,  $V_{CC} = 12\text{V}$ , unless otherwise noted.

Symbol	Parameter	Conditions	Min.	Typ.	Max.	Unit
<b>Supply</b>						
$V_{DD}$	Input Voltage		3.5	-	18	V
$I_{DD1}$	Supply Current Of Operation Mode	IC is in operation mode No Load	-	2	4	mA
$I_{DD2}$	Supply Current Of Lock Mode	IC is in lock mode No Load	-	2	4	mA
$I_{DD3}$	Supply Current Of Standby Mode	IC is in standby mode No Load	-	2	4	mA
$V_{VOUT}$	VREF Pin Output Voltage	$I_{VOUT} = 5\text{mA}$	-	4.8	-	V
<b>Output</b>						
$R_{DS(ON)}$	Output On-Resistance	$I_O = 1.5\text{A}$ Upper and Lower total	-	0.22	-	$\Omega$
<b>RD</b>						
$R_{RD(ON)}$	Output On-Resistance	$I_O = 10\text{mA}$	-	25	-	$\Omega$
$I_{RD}$	RD Pin Off Leakage Current	-	-	<0.1	1	$\mu\text{A}$
<b>HALL Switch Signal Input Threshold</b>						
$V_{HW\_H}$	Input Signal High level	-	0.8	-	-	V
$V_{HW\_L}$	Input Signal low level	-	-	-	0.4	V
<b>FR Signal Input Threshold</b>						
$V_{FR\_H}$	Input Signal High level	-	0.8	-	-	V
$V_{FR\_L}$	Input Signal low level	-	-	-	0.4	V
<b>Protection</b>						
$V_{UVLO}$	Input UVLO rising threshold	-	-	2.9	-	V
$V_{UVLO\_HYS}$	Input UVLO hysteresis	-	-	0.2	-	V
$T_{ON}$	Locked Protection On Time	-	-	0.6	-	Sec
$T_{OFF}$	Locked Protection Off Time	-	-	3.6	-	Sec
$T_{SD}$	Thermal Shutdown Temperature	-	-	175	-	$^{\circ}\text{C}$
$T_{SH}$	Thermal Shutdown Hysteresis	-	-	30	-	$^{\circ}\text{C}$
$I_{OCP}$	Over-current limit protection threshold	-	-	5.5	-	A
$I_{LIM1}$	Output current limit1 (Operation Mode)	-	-	4.5	-	A
$I_{LIM2}$	Output current limit2 (Lock & Restart mode)	TSSOP-16L-EP	-	0.5	-	A
$V_{ESD}$	Human Body Model (HBM) ESD		4	-	-	KV
<b>Soft Start</b>						
$T_{SS}$	Soft Start Time	TSSOP-16L-EP	-	5	-	Sec
<b>PWM Control</b>						
$V_{PWM\_H}$	Pulse Mode PWM Input High Level Voltage	-	2	-	-	V
$V_{PWM\_L}$	Pulse Mode PWM Input Low Level Voltage	-	-	-	0.8	V
$F_{PWM}$	PWM Input Frequency	-	15	-	60	kHz
$F_{OUT}$	Output PWM Switch Frequency	-	-	26	-	kHz
<b>Soft Switch</b>						
$\theta_{SON\_100}$	Soft turn-on angle	IC is in operation mode PWM floating	-	24	-	$^{\circ}$
$\theta_{SOFF\_100}$	Soft turn-off angle	IC is in operation mode PWM floating	-	45	-	$^{\circ}$



■ Truth Table

INPUT		OUTPUT			Mode
FR	HW	OUT1	OUT2	RD	
H	H	H	L	L	Operation Mode
H	L	L	H	L	
L	H	L	H	L	
L	L	H	L	L	
H	Hold H	L	L	OFF (H)	Lock Mode
H	Hold L	L	L	OFF (H)	
L	Hold H	L	L	OFF (H)	
L	Hold L	L	L	OFF (H)	



■ Operating Diagram

VCC = 12V, T<sub>A</sub> = 25°C, tested with fan unit, unless otherwise noted.

Typical Waveform, Full speed,  
measure phase current

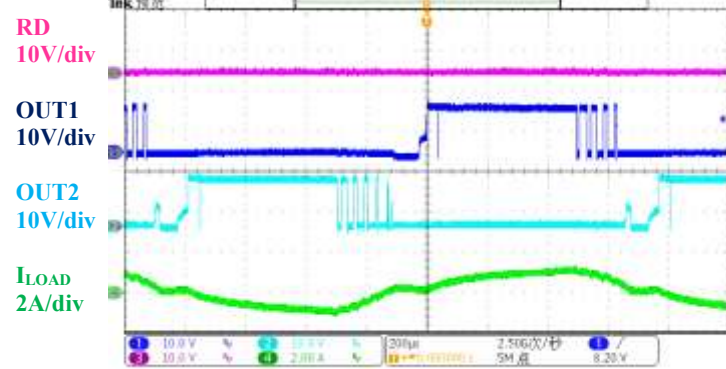

200us/div

Typical Waveform, Full speed,  
measure line current

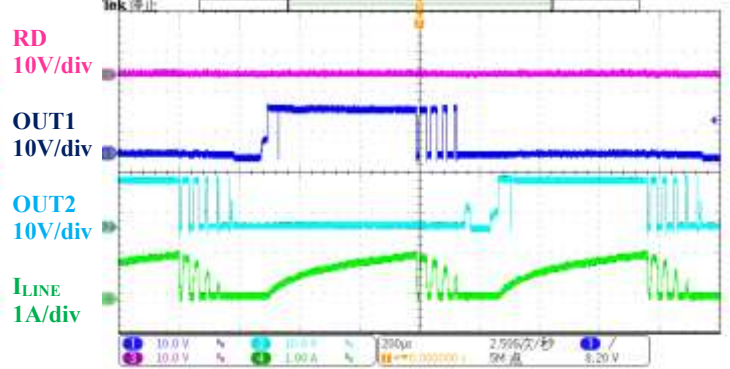

200us/div

Typical Waveform, Switch SoftON & SoftOFF,  
measure phase current

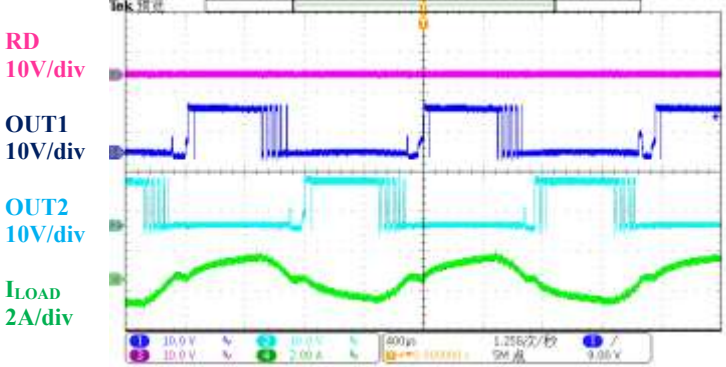

400us/div

Typical Waveform, Switch SoftON & SoftOFF,  
measure line current

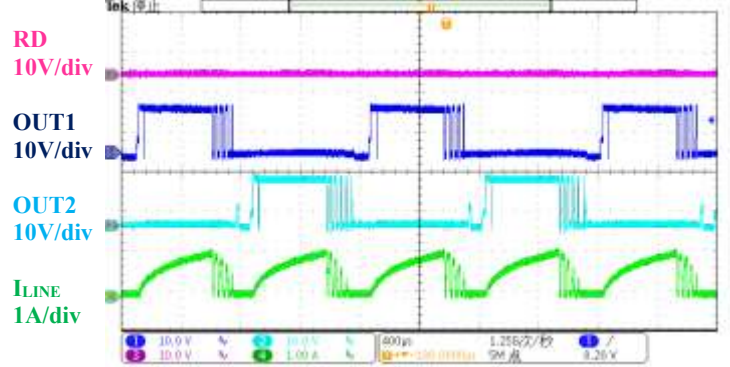

400us/div

Typical Waveform, Soft Start,  
measure phase current

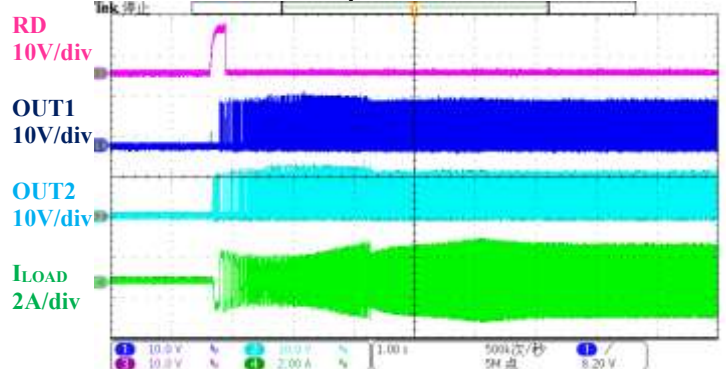

1s/div

Typical Waveform, Soft Start,  
measure line current

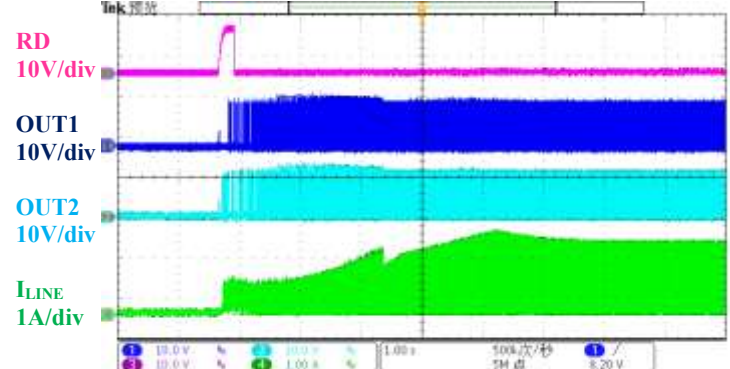

1s/div



Typical Waveform, Lock & Restart,  
measure phase current

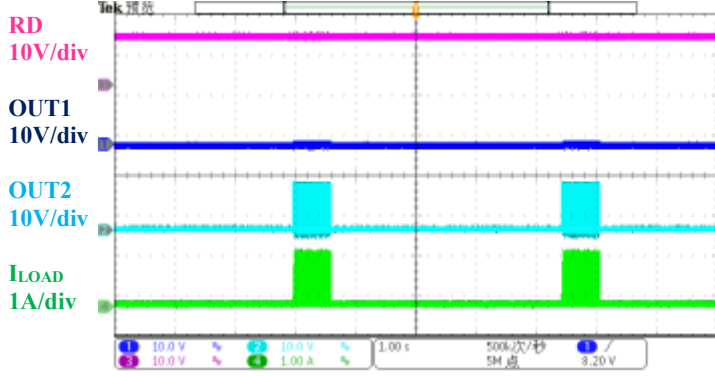

1s/div

Typical Waveform, Lock & Restart,  
measure line current

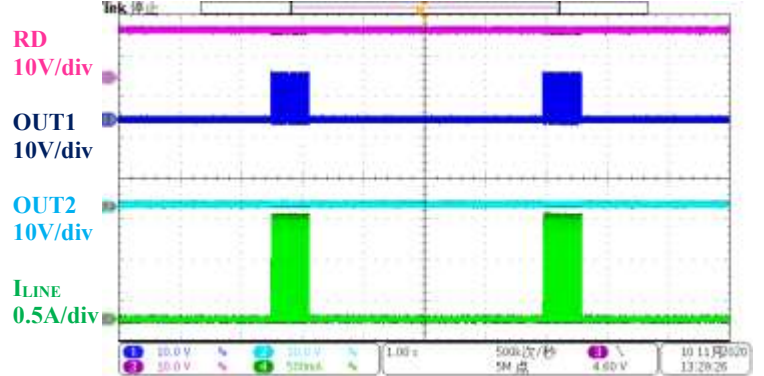

1s/div



## ■ Function Description

### Speed Control

The OCH2993R is controlled using a PWM input interface, which is compatible with industry standard devices. The IC detects the PWM input signal duty cycle and linearly controls the H-bridge output duty cycle, so the fan speed increases as the input duty cycle increases. The PWM input accepts a wide input frequency range (15 KHz to 60 kHz), while the output frequency is kept constant at 26 kHz above the audible frequency range.

### PWM Output Drive

The IC controls the H-bridge MOSFET switching to reduce speed variation and increase system efficiency (see Figure 2).

With this HW signal of external Hall switch IC, IC does soft on transition and soft off transition to keep smooth current and reduce fan vibration.

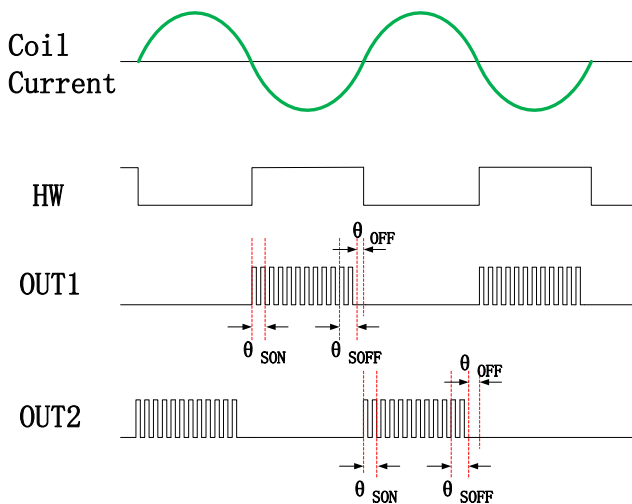

### Soft Switch

During soft turn-on section, OUT1 continues switching, and the duty cycle increases gradually from 0 to the target setting duty cycle in max.16 steps while OUT2 remains low. The soft on angle last for  $24^\circ$  when output duty cycle is 100%.

During soft turn-off section, OUT1 continues switching, and the duty cycle decreases gradually from the target setting duty cycle to 0 in max.16 steps while OUT2 remains low. The soft on angle last for  $45^\circ$  when output duty cycle is 100%.

During off time, OUT1 remains at high impedance. OUT2 remains low. The time duration is adaptive

from  $0^\circ$  to  $45^\circ$ . In steady state, this function block maintains the phase lock of the HW signal falling edge and winding current zero-crossing edge.

For the HW signal low interval, the conducting phase changes, but the switching sequence remains the same.

### Soft Start

The OCH2993R provides the soft-start function to avoid peak current at power-on and lock-restart moments. The soft start function initial duty is 0%, if HW signal change four times the duty will trace input target duty, else duty from Duty\_2Hall to 100% in 5 sec(typ.).

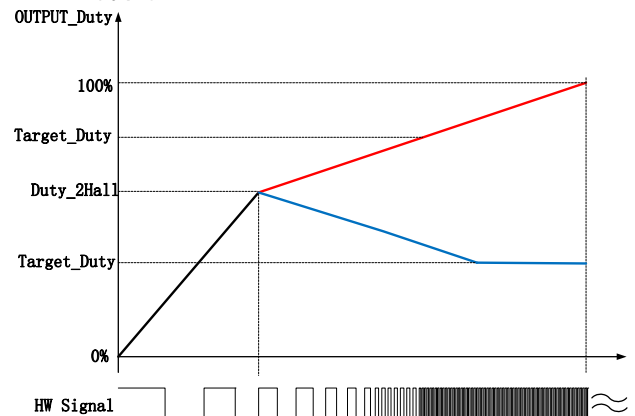

In order to further reduce the peak current, the OCH2993R is built in current limit (typical 1.2A/0.5A determined by package) at power-on and lock-restart moments. When the current limit function is triggered, the output duty will be maintained until HW signal change four times, and then the duty traces input target duty.

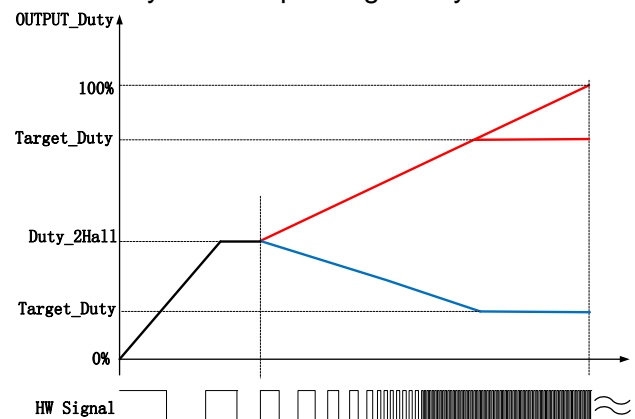



**Minimum Output Duty setting**

OCH2993R is built in minimum output duty setting function. It's set by the MINSP voltage.

**1)  $V_{MINSP} > 0.6 * V_{VOUT}$**

When  $V_{MINSP} > 0.6 * V_{VOUT}$  (include MINSP pin floating), the minimum output duty setting function is set internally (default 10%). In this Case, if PWM input duty is less than the minimum output duty setting internally, IC will enter into minimum speed mode.

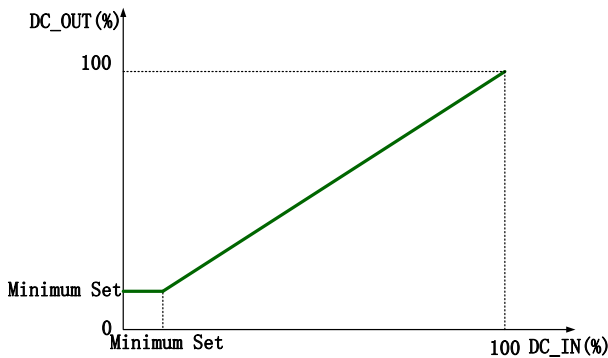

**2)  $V_{MINSP} < 0.2 * V_{VOUT}$**

When  $V_{MINSP} < 0.2 * V_{VOUT}$  (include MINSP pin connect to GND), if PWM input duty is less than the 10%, the IC will enter into shutdown mode.

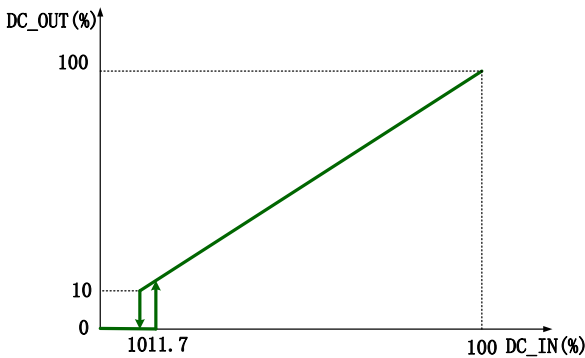

**3)  $0.2 * V_{VOUT} < V_{MINSP} < 0.6 * V_{VOUT}$**

When  $0.2 * V_{VOUT} < V_{MINSP} < 0.6 * V_{VOUT}$ , the minimum output duty setting function is set by  $R_{MINSP}$  and  $R1$ . In this Case, if PWM input duty is less than the minimum output duty setting, IC will enter into minimum speed mode.

In this case, the Minimal Speed input allows setting of a minimum required rotation speed of the motor by using 2 inexpensive resistors. This is especially useful for applications where minimum cooling is a requirement to avoid system damage (example: computer CPU, graphics processor, etc).

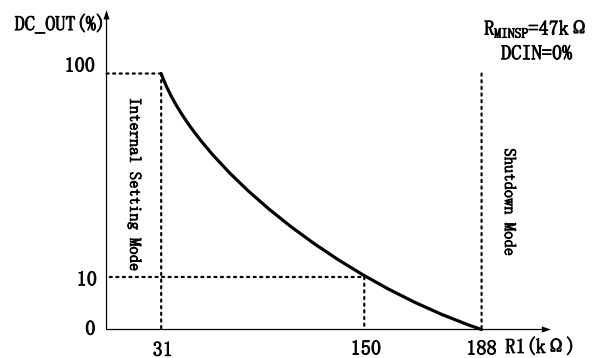
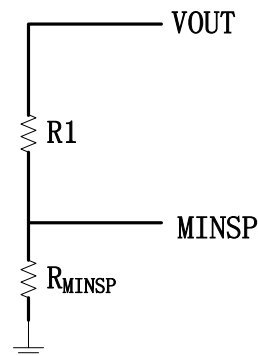

### Protection Circuits

The OCH2993R is fully protected against overvoltage, under-voltage, over-current, current-limit, over temperature events and has lock and restart protection.

#### Under-Voltage Lockout (UVLO)

If at any time VCC falls below the under-voltage lockout (UVLO) threshold voltage, all circuitry in the device is disabled, and the internal logic is reset. Operation resumes when VCC rises above the UVLO threshold.

#### Over-Current Protection (OCP) and Power On Short-Circuit Detection

The OCH2993R protects against short circuit by detecting the current flowing through two low-side MOSFETs (LS-FET). If the current flowing through any MOSFET exceeds the over-current protection (OCP) threshold after about 1.5  $\mu$ s of blanking time, that all MOSFETs turns off immediately. After approximately 3.6s of delay, the bridge is re-enabled automatically. The OCP current threshold is 5.5A(typical).

And When IC power on, if OUT1 or OUT2 is short to GND, the built short circuit by detecting two high-side MOSFETs, the HS-FET turns off immediately and turns on the two low-side MOSFETs (LS-FET) until the short-circuit condition is removed.

#### Overload Current Limit

During normal switching, if the current flowing

through the low-side MOSFET (LS-FET) of the H-bridge exceeds the threshold after around 1.5  $\mu$ s of blanking time, the HS-FET turns off immediately. The HS-FET resumes switching in the next switching cycle. The overload current limit is 4.5A (typical).

#### Thermal Shutdown

Thermal monitoring is also integrated into the OCH2993R. If the die temperature rises above 155°C, the IC turns off the two HS-FETs and turns on the two low-side MOSFETs (LS-FET). Once the die temperature has fallen to a safe level, operation resumes automatically.

#### Rotor Lock and Restart Protection

If the IC cannot see the HW signal edge change during the 0.6s detection time, all MOSFETs of the H bridge are turned off. After 3.6s of recovery time, the IC attempts to start up again automatically.

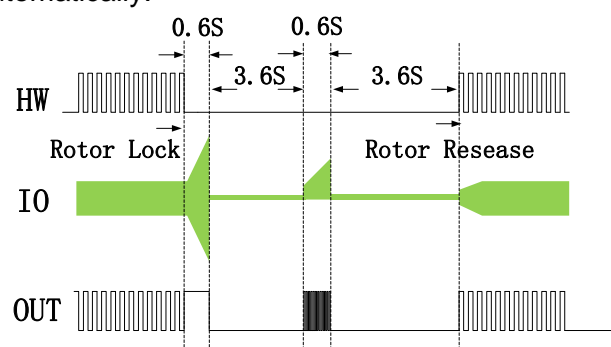

■ **Application Information**

**Input Protection Diode & Capacitor**

The IC should be added a protection diode (D1) to prevent the damage from the power reverse connection. However, the protection diode will cause a voltage drop on the supply voltage. The current rating of the diode must be greater than the maximum output current.

Place an input capacitor (C1) near VCC to keep the input voltage stable and reduce input switching voltage noise and ripple. The input capacitor impedance must be low at the switching frequency. Ceramic capacitors with X7R dielectrics are recommended for their low ESR characteristics. Ensure that the ceramic capacitance is dependent on the voltage rating. The DC bias voltage and value can lose as much as 50% of its capacitance at its rated voltage rating. Leave enough voltage

rating margins when selecting the component. For most applications, a 4.7μF to 10μF ceramic capacitor is sufficient. In some applications, add an additional, large, electrolytic capacitor to absorb inductor energy if needed.

**Input Snubber Circuit**

Due to the input capacitor energy charge/discharge during the phase transition soft switching, the input current has switching cycle ringing. If needed, add a 1~2Ω resistor in series with a 10μF~22uF capacitor as an R-C.

**Input Clamping TVS**

To avoid high voltage spikes caused by the energy stored in the motor inductor charges back to the input capacitor side, must add a voltage clamping transient voltage suppressor (TVS)diode. For a 12V case, a 16.8V/SOD-123 package TVS diode is sufficient.

■ **Marking Information**

TSSOP-16L-EP:

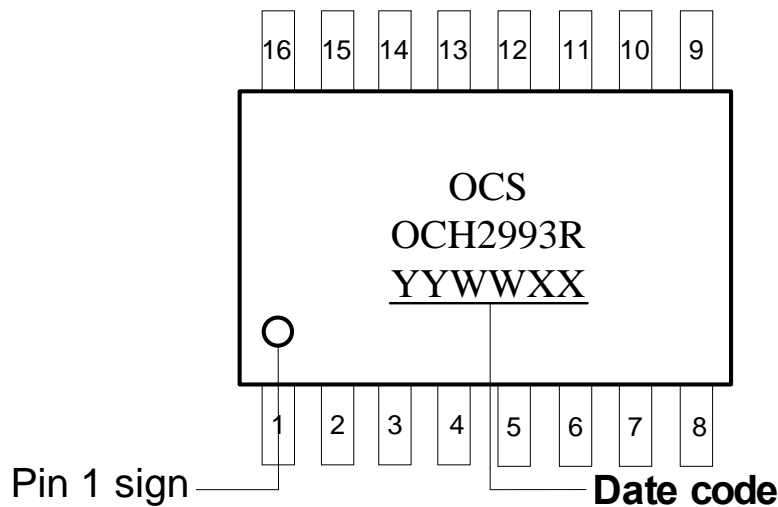

■ Package Information

TSSOP-16L-EP

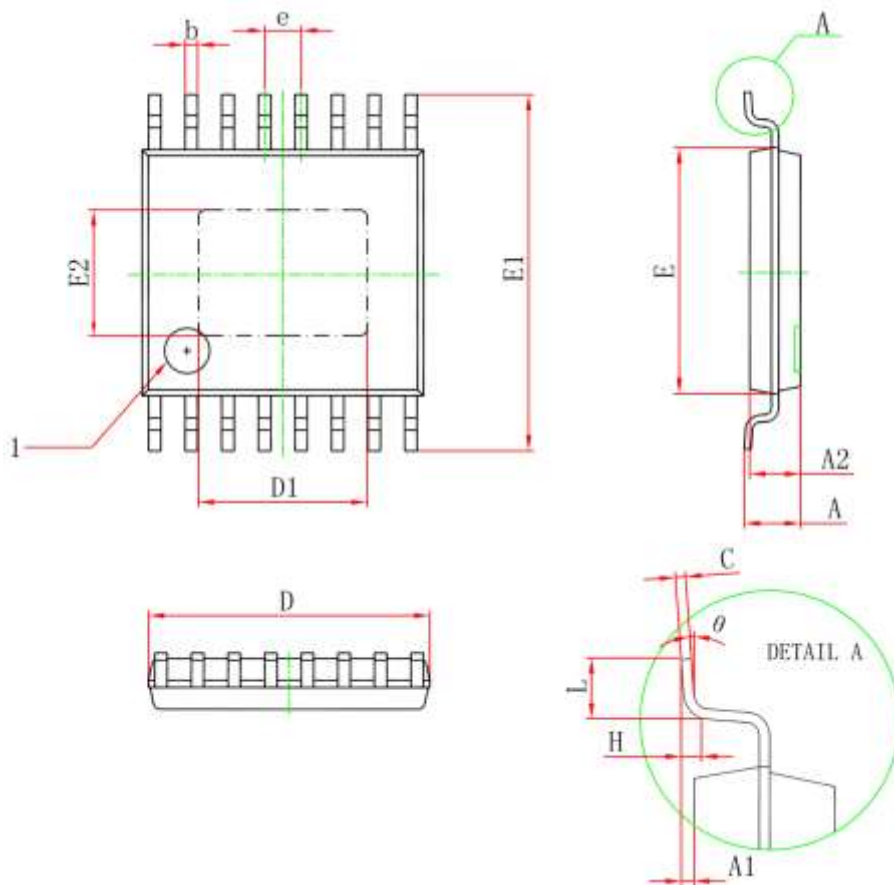

Symbol	Dimensions In Millimeters		Dimensions In Inches	
	Min.	Max.	Min.	Max.
D	4.900	5.100	0.193	0.201
D1	2.900	3.100	0.114	0.122
E	4.300	4.500	0.169	0.177
b	0.190	0.300	0.007	0.012
c	0.090	0.200	0.004	0.008
E1	6.250	6.550	0.246	0.258
E2	2.200	2.400	0.087	0.094
A		1.150		0.043
A2	0.800	1.000	0.031	0.039
A1	0.020	0.150	0.001	0.006
e	0.65 (BSC)		0.026(BSC)	
L	0.500	0.700	0.02	0.028
H	0.25(T YP)		0.01(T YP)	
$\theta$	1°	7°	1°	7°



■ Packing information

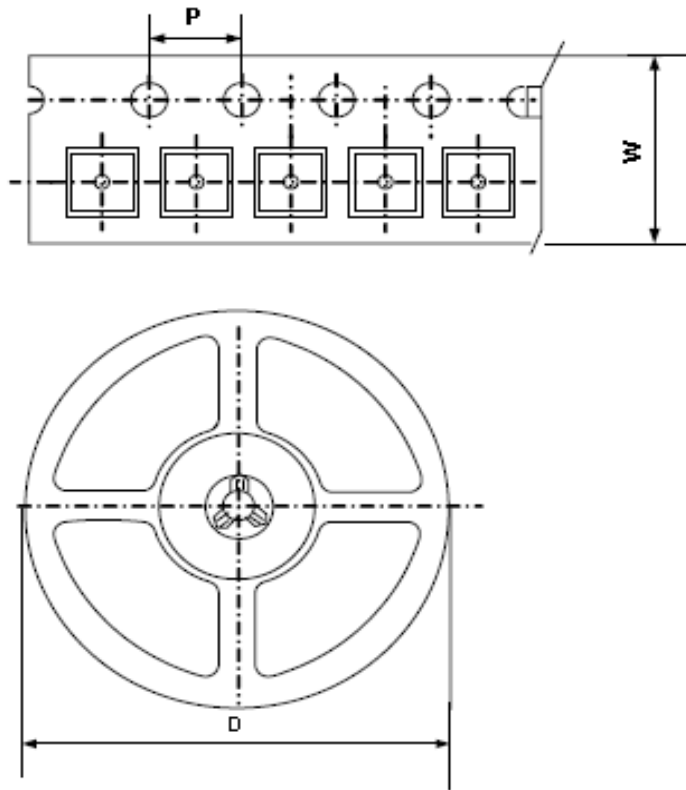

Package Type	Carrier Width(W)	Pitch(P)	Reel Size(D)	Packing Minimum
TSSOP-16L-EP	12.0±0.1 mm	4.0±0.1 mm	330±1 mm	2500pcs

Note: Carrier Tape Dimension, Reel Size and Packing Minimum



IMPORTANT NOTICE

Orient-Chip Semiconductor Co., Ltd. (OCS) and its subsidiaries reserve the right to make corrections, modifications, enhancements, improvements and other changes to its products. Customers should obtain the latest relevant information before placing orders and should verify that such information is current and complete. These separate provisions won't be provided.

